

GREEN WOODLANDS BARN  
GABLE END BRACKET  
FRAMING  
Not to Scale

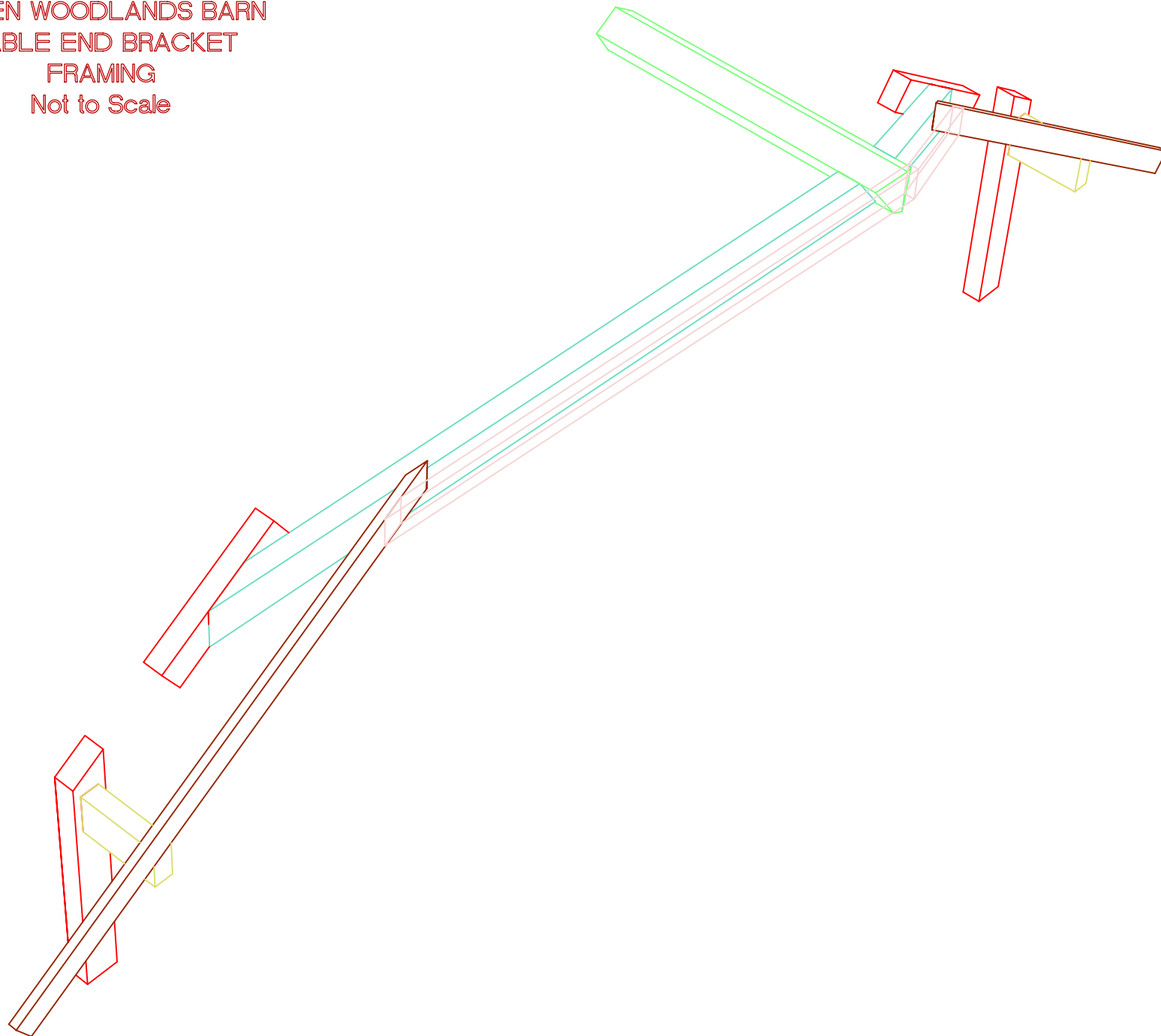

GREEN WOODLANDS BARN  
SECTION at LOWER GABLE END BRACKET

Scale:  $1\frac{1}{2}" = 1'-0"$

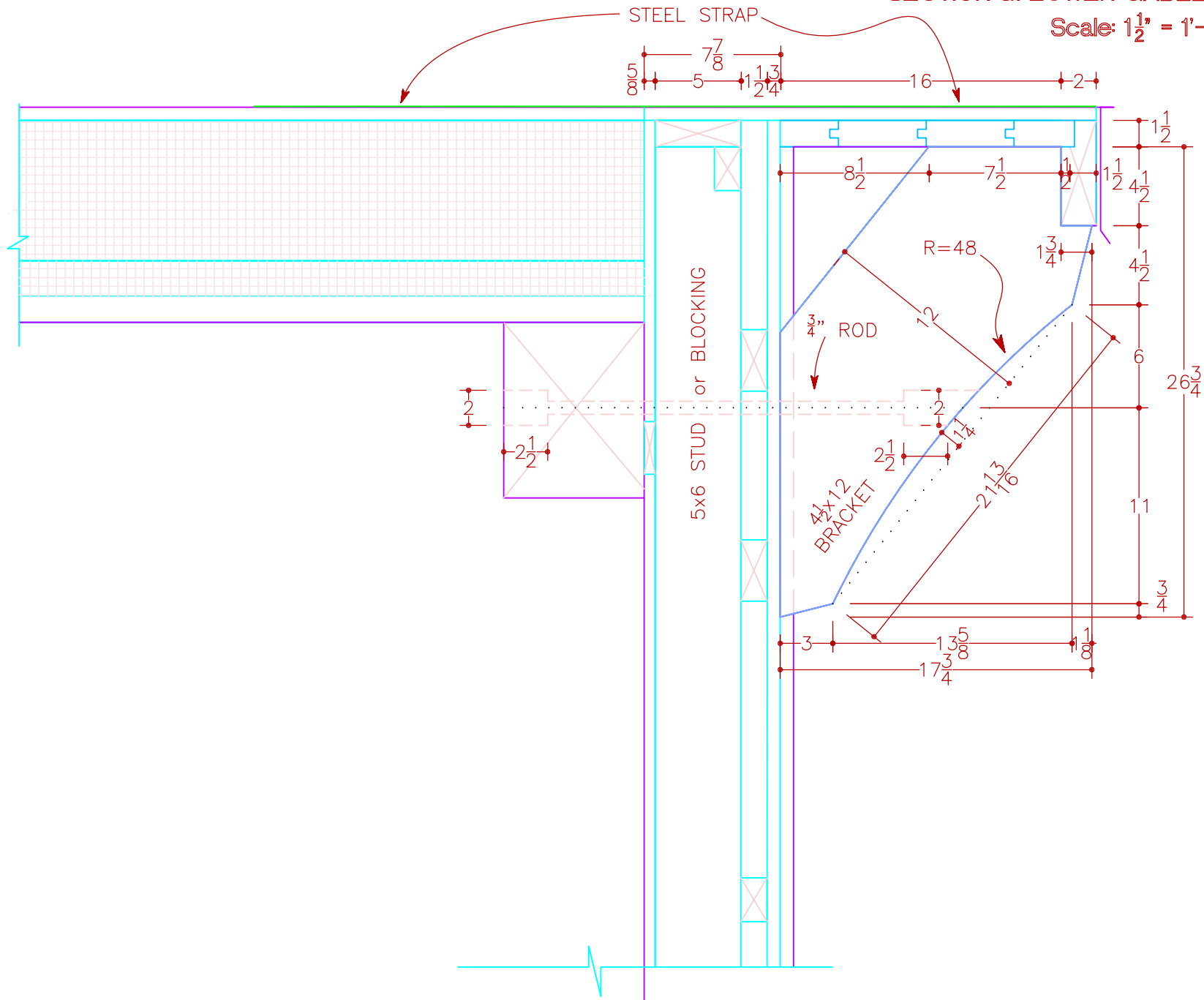

# GREEN GABLE BRACKETS

# VALLEY (left)

# 5x10x16

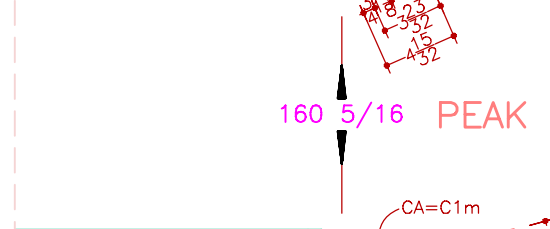
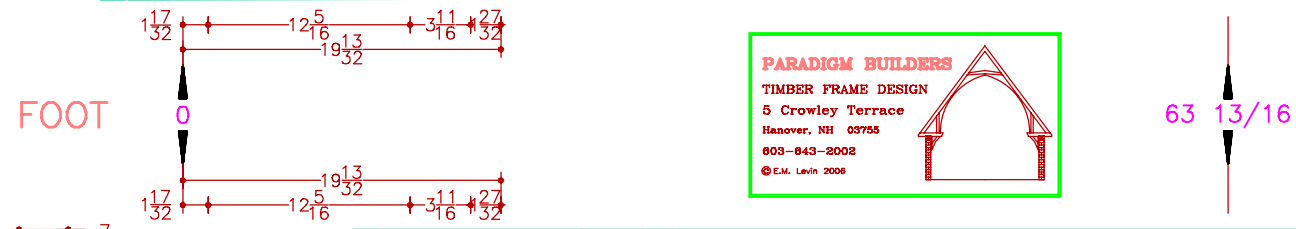
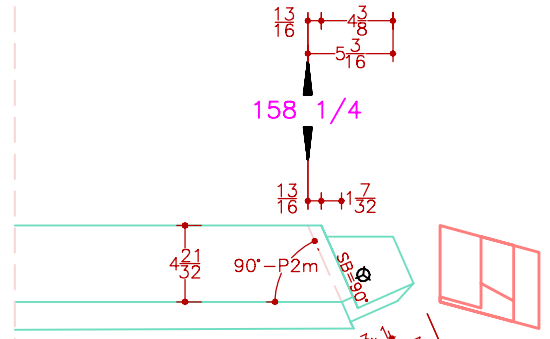
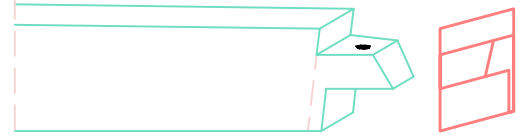

**PARADIGM BUILDERS**  
 TIMBER FRAME DESIGN  
 5 Crowley Terrace  
 Hanover, NH 03755  
 603-843-2002  
 © E.M. Levin 2006

63 13/16

PEAK

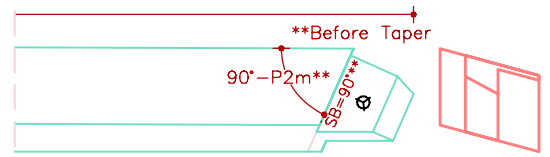
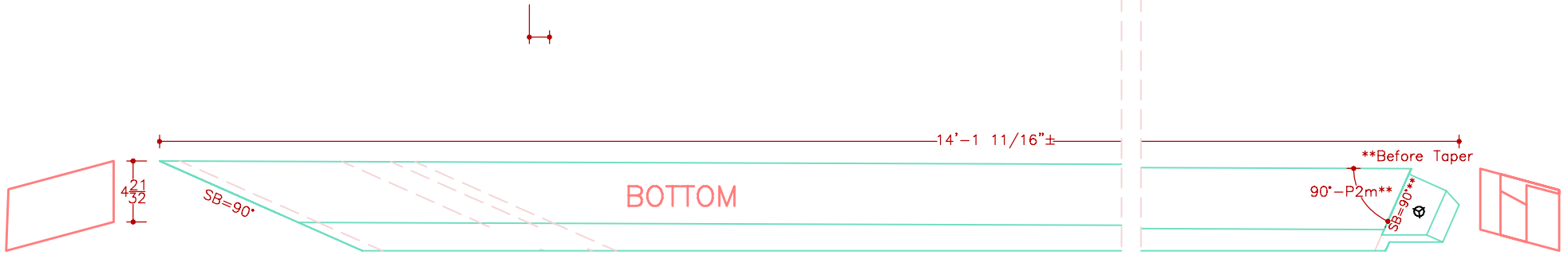
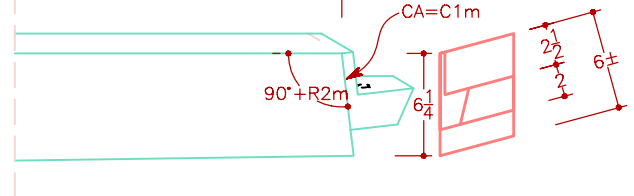

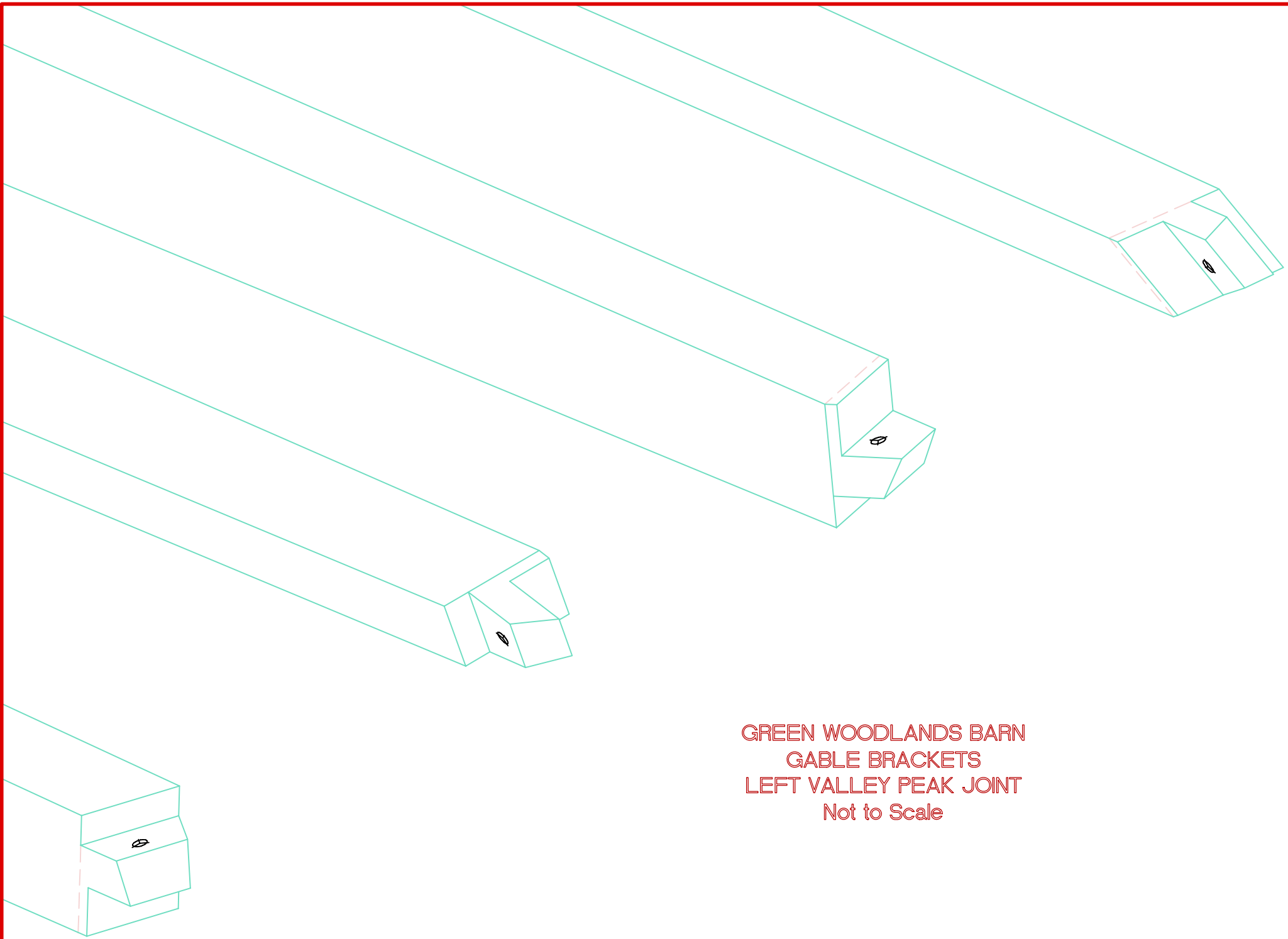

GREEN WOODLANDS BARN  
GABLE BRACKETS  
LEFT VALLEY PEAK JOINT  
Not to Scale

GREEN GABLE BRACKETS

VALLEY (right)

5x10x16

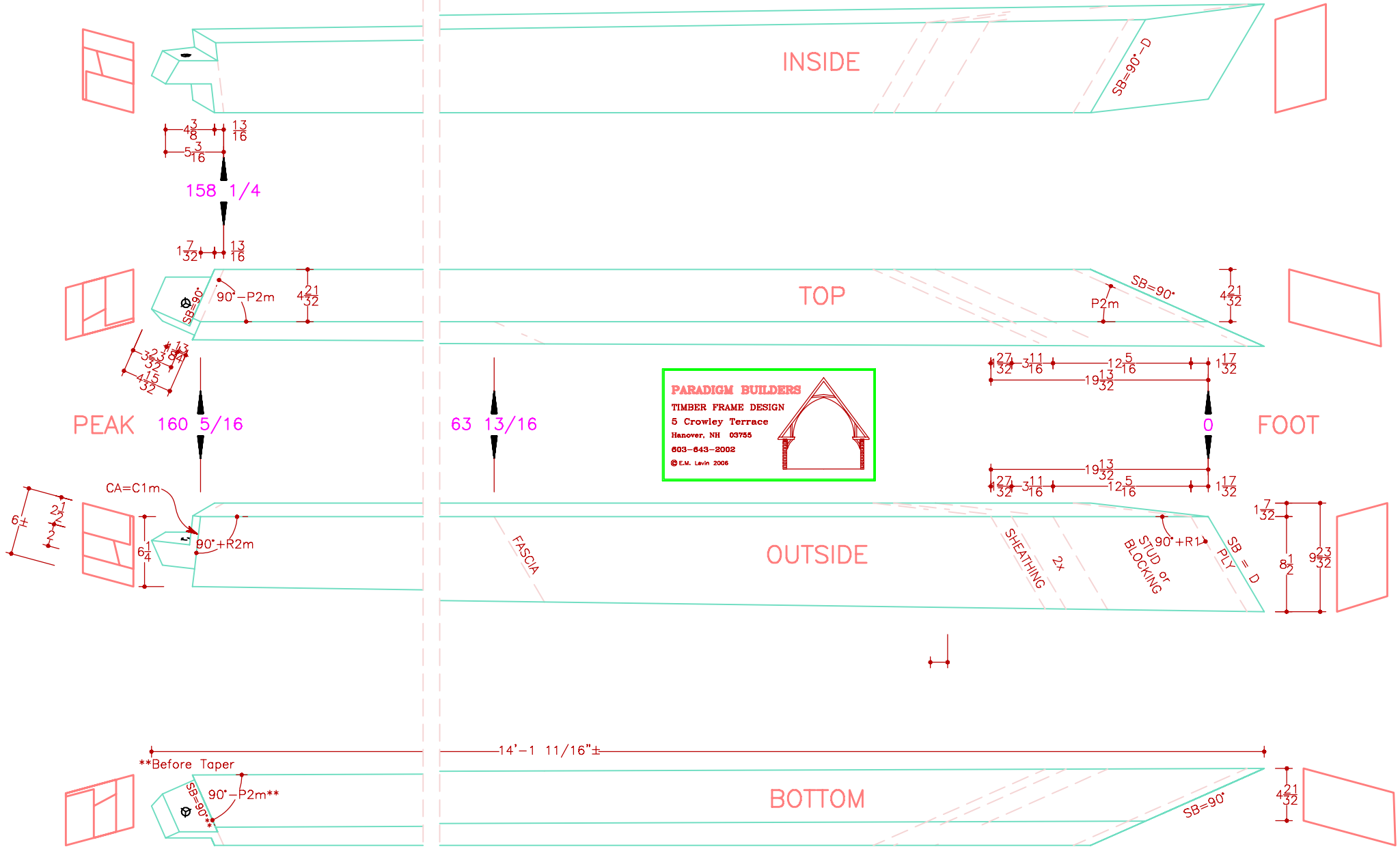

**PARADIGM BUILDERS**  
 TIMBER FRAME DESIGN  
 5 Crowley Terrace  
 Hanover, NH 03755  
 603-643-2002  
 © E.M. Levin 2006

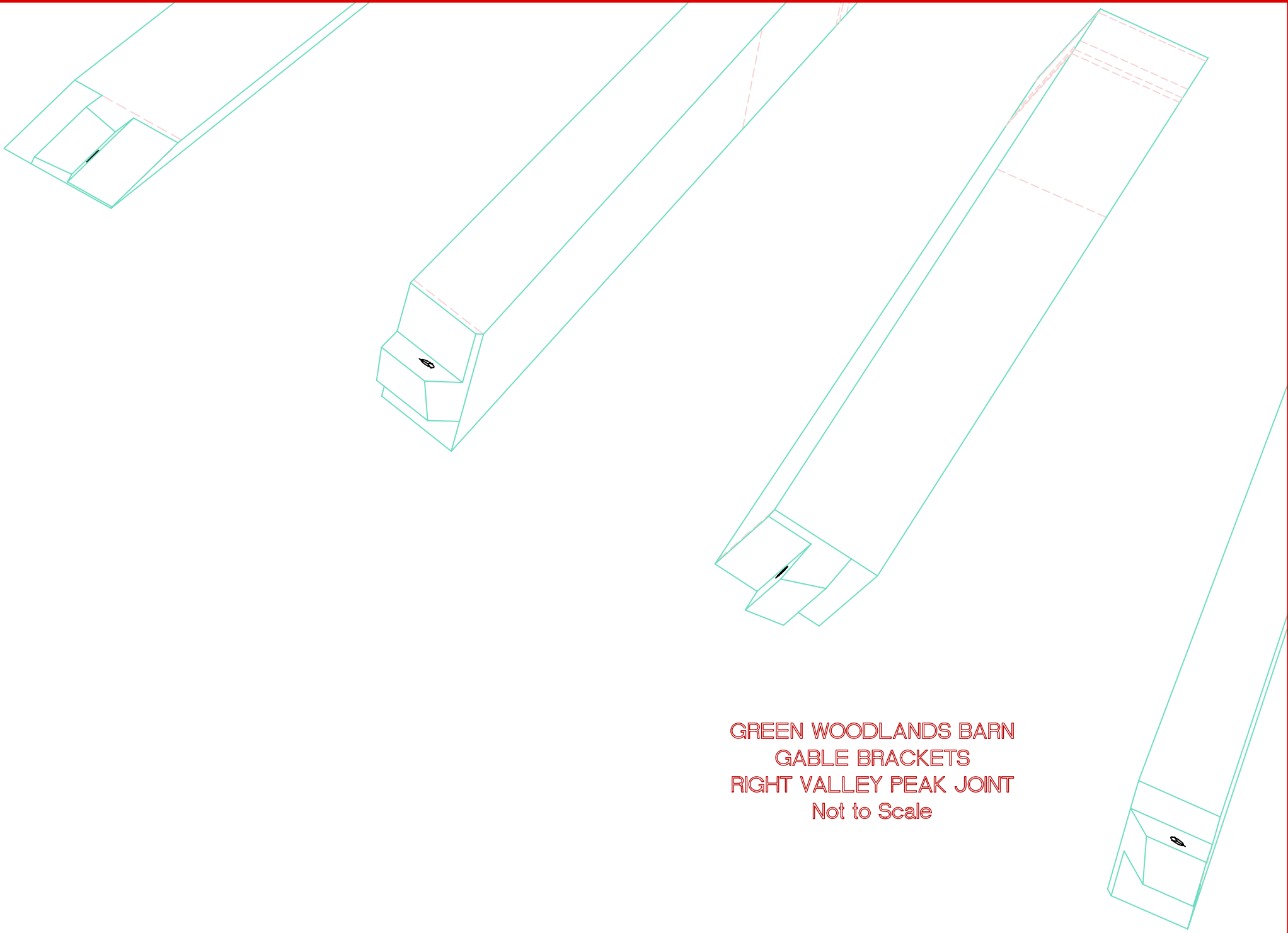

GREEN WOODLANDS BARN  
GABLE BRACKETS  
RIGHT VALLEY PEAK JOINT  
Not to Scale

RIDGE

GREEN GABLE BRACKETS

9x9x6

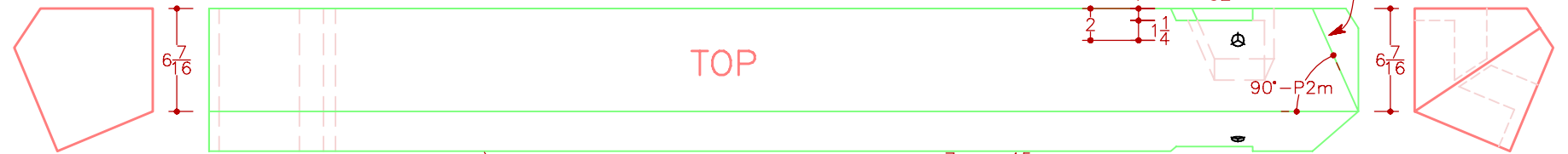

INBOARD

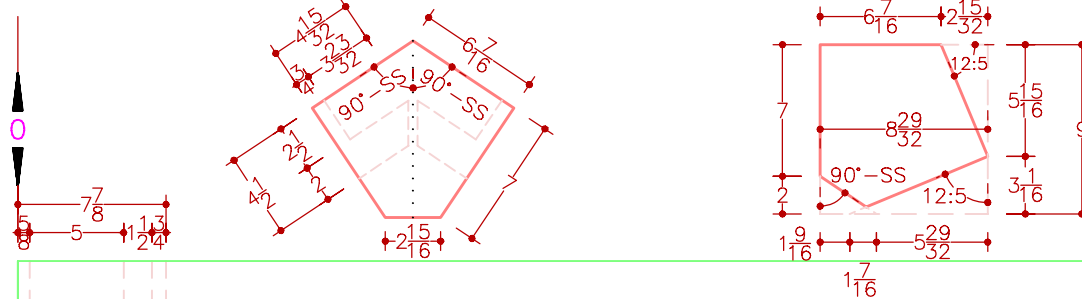

71 5/8 OUTBOARD



**PARADIGM BUILDERS**  
 TIMBER FRAME DESIGN  
 5 Crowley Terrace  
 Hanover, NH 03755  
 603-643-2002  
 © E.M. Levin 2006

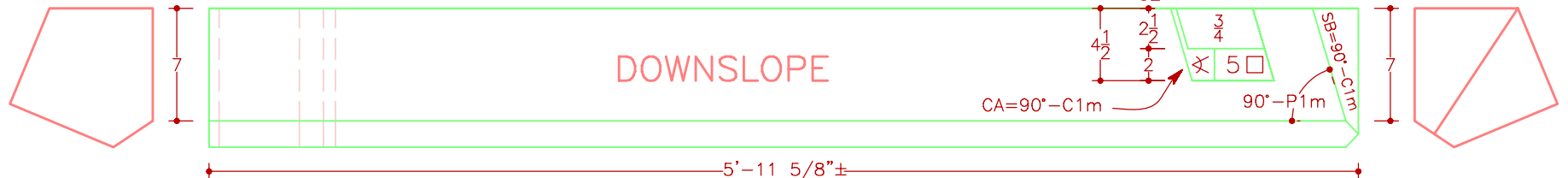

5'-11 5/8"±

November 13, 2006

GREEN WOODLANDS GABLE BRACKETS  
Hawkindale Angles

DD = 61.9275° = 22 1/2 : 12	D = 28.0725° = 6 13/32 : 12
SS = 33.6901° = 8 : 12	S = 51.3402° = 15 : 12
R1 = 30.4655° = 7 1/16 : 12	R1 = 30.4655° = 7 1/16 : 12
R2m = 6.6075° = 1 3/8 : 12	R2a = 38.9046° = 9 11/16 : 12
R3m = 23.1891° = 5 1/8 : 12	R3a = 40.3284° = 10 3/16 : 12
R4m = 24.6882° = 5 17/32 : 12	R4a = 58.2523° = 19 13/32 : 12
R5m = 15.4730° = 3 5/16 : 12	R5a = 27.4307° = 6 7/32 : 12
R6m = 23.0436° = 5 3/32 : 12	R6a = 5.8592° = 1 7/32 : 12
R7m = 5.5901° = 1 3/16 : 12	R7a = 25.1278° = 5 5/8 : 12
P1m = 16.4803° = 3 9/16 : 12	P1a = 55.6669° = 17 9/16 : 12
P2m = 23.9297° = 5 5/16 : 12	P2a = 49.5110° = 14 1/16 : 12
P3m = 13.8834° = 2 31/32 : 12	P3a = 31.6857° = 7 13/32 : 12
P4m = 22.1978° = 4 29/32 : 12	P4a = 20.4349° = 4 15/32 : 12
P5m = 57.3407° = 18 23/32 : 12	P5a = 18.4266° = 4 : 12
P6m = 6.2593° = 1 5/16 : 12	P6a = 35.8672° = 8 11/16 : 12
C1m = 23.0512° = 5 3/32 : 12	C1a = 33.4495° = 7 15/16 : 12
C2m = 6.0779° = 1 9/32 : 12	C2a = 31.6014° = 7 3/8 : 12
C5m = 15.1315° = 3 1/4 : 12	C5a = 43.5512° = 11 13/32 : 12
A5m = 13.8038° = 2 15/16 : 12	A5a = 26.5751° = 6 : 12
A6m = 12.3019° = 2 5/8 : 12	A6a = 25.7382° = 5 25/32 : 12
A7m = 17.4180° = 3 3/4 : 12	A7a = 47.8025° = 13 1/4 : 12
A8m = 1.7320° = 3/8 : 12	A8a = 29.0760° = 6 11/16 : 12
A9m = 8.7296° = 1 27/32 : 12	A9a = 22.0625° = 4 7/8 : 12